



240W Constant Voltage + Constant Current LED Driver **HBG-240P** series



■ Features

- Constant Voltage + Constant Current mode output
- Circular shape PCB type design
- Built-in active PFC function
- Function options: output adjustable via potentiometer;
3 in 1 dimming
- Typical lifetime > 50000 hours
- 5 years warranty

■ Applications

- LED bay lighting
- LED down lighting
- LED spot lighting
- LED mining lighting
- LED stage lighting

■ Description

HBG-240P series is a 240W AC/DC PCB type LED driver featuring the circular shape design. It operates from 90~305VAC and offers the dual mode constant voltage and constant current output models with different rated voltage ranging between 36V and 60V. Thanks to the high efficiency up to 93.5%, with the fanless design, the entire series is able to operate for -40°C ~ +45°C under free air convection. HBG-240P is equipped with various function options, such as dimming methodology, so as to provide the optimal design flexibility for LED lighting system.

■ Model Encoding

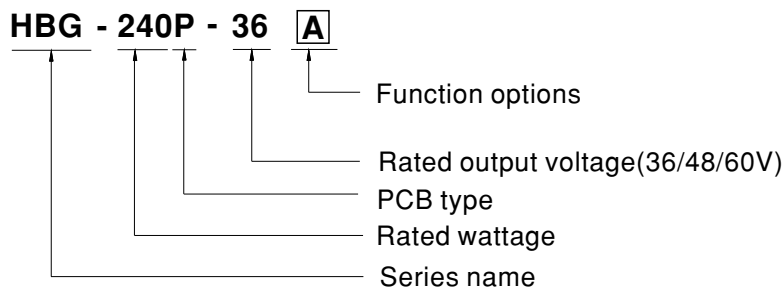

Type	Function	Note
A	Io adjustable through built-in potentiometer.	In Stock
B	3 in 1 dimming function (1~10Vdc, 10V PWM signal and resistance)	In Stock



240W Constant Voltage + Constant Current LED Driver **HBG-240P** series

SPECIFICATION

MODEL		HBG-240P-36 <input type="checkbox"/>	HBG-240P-48 <input type="checkbox"/>	HBG-240P-60 <input type="checkbox"/>
OUTPUT	DC VOLTAGE	36V	48V	60V
	CONSTANT CURRENT REGION <small>Note.2</small>	21.6 ~ 36V	28.8 ~ 48V	36 ~ 60V
	RATED CURRENT	6.7A	5A	4.0A
	RATED POWER <small>Note.5</small>	241.2W	240W	240W
	RIPPLE & NOISE (max.) <small>Note.3</small>	250mVp-p	250mVp-p	350mVp-p
	CURRENT ADJ. RANGE	Adjustable for A-Type only (via built-in potentiometer)		
		4.0 ~ 6.7A	3 ~ 5A	2.4 ~ 4.0A
	VOLTAGE TOLERANCE <small>Note.4</small>	±2.0%		
	LINE REGULATION	±0.5%		
	LOAD REGULATION	±0.5%		
SETUP, RISE TIME <small>Note.6</small>	2500ms, 120ms / 115VAC	500ms, 120ms / 230VAC		
HOLD UP TIME (Typ.)	15ms/115VAC, 230VAC			
INPUT	VOLTAGE RANGE <small>Note.5</small>	90 ~ 305VAC 127 ~ 431VDC (Please refer to "STATIC CHARACTERISTIC" section)		
	FREQUENCY RANGE	47 ~ 63Hz		
	POWER FACTOR	PF ≥ 0.98/115VAC, PF ≥ 0.94/230VAC, PF ≥ 0.9/277VAC@full load (Please refer to "POWER FACTOR (PF) CHARACTERISTIC" section)		
	TOTAL HARMONIC DISTORTION	THD < 20% (@load ≥ 60%/115VAC, 230VAC; @load ≥ 75%/277VAC) (Please refer to "TOTAL HARMONIC DISTORTION (THD)" section)		
	EFFICIENCY (Typ.)	92.5%	93%	93.5%
	AC CURRENT	2.8A / 115VAC	1.4A / 230VAC	1.2A / 277VAC
	INRUSH CURRENT (Typ.)	COLD START 75A (width=680μs measured at 50% Ipeak) at 230VAC; Per NEMA 410		
	MAX. No. of PSUs on 16A CIRCUIT BREAKER	2 units (circuit breaker of type B) / 3 units (circuit breaker of type C) at 230VAC		
PROTECTION	LEAKAGE CURRENT	<0.75mA / 277VAC		
	OVER CURRENT	95 ~ 108% Constant current limiting, recovers automatically after fault condition is removed		
	SHORT CIRCUIT	Hiccup mode, recovers automatically after fault condition is removed.		
	OVER VOLTAGE	43 ~ 52V	52 ~ 63V	62 ~ 85V
	OVER TEMPERATURE	Shut down o/p voltage, recovers automatically after temperature goes down		
ENVIRONMENT	WORKING TEMP.	Ta = -40 ~ +45°C (Please refer to "OUTPUT LOAD vs TEMPERATURE" section)		
	WORKING HUMIDITY	20 ~ 95% RH non-condensing		
	STORAGE TEMP., HUMIDITY	-40 ~ +80°C, 10 ~ 95% RH		
	TEMP. COEFFICIENT	±0.03%/°C (0 ~ 50°C)		
	VIBRATION	10 ~ 500Hz, 2G 12min./1cycle, period for 72min. each along X, Y, Z axes		
SAFETY & EMC	SAFETY STANDARDS	UL8750, CSA C22.2 No.250.13-12; ENEC EN61347-1, EN61347-2-13, EN62384, GB19510.1, GB19510.14 approved		
	WITHSTAND VOLTAGE	I/P-O/P: 3.75KVAC I/P-FG: 2KVAC O/P-FG: 0.5KVAC		
	ISOLATION RESISTANCE	I/P-O/P, I/P-FG, O/P-FG: 100M Ohms / 500VDC / 25°C / 70% RH		
	EMC EMISSION	Compliance to EN55015, EN55022 (CISPR22) Class B, EN61000-3-2 Class C (@load ≥ 75%); EN61000-3-3, GB17743, GB17625.1		
	EMC IMMUNITY	Compliance to EN61000-4-2, 3, 4, 5, 6, 8, 11, EN61547, light industry level (surge immunity: Line-Earth: 4KV, Line-Line: 2KV)		
OTHERS	MTBF	175Khrs min. MIL-HDBK-217F (25°C)		
	DIMENSION	Refer to mechanical specification		
	PACKING	0.62Kg; 20pcs/13.4Kg/1.11CUFT		
NOTE	<ol style="list-style-type: none"> All parameters NOT specially mentioned are measured at 230VAC input, rated current and 25°C of ambient temperature. Please refer to "DRIVING METHODS OF LED MODULE". Ripple & noise are measured at 20MHz of bandwidth by using a 12" twisted pair-wire terminated with a 0.1uF & 47uF parallel capacitor. Tolerance : includes set up tolerance, line regulation and load regulation. De-rating may be needed under low input voltages. Please refer to "STATIC CHARACTERISTIC" sections for details. Length of set up time is measured at first cold start. Turning ON/OFF the driver may lead to increase of the set up time. The driver is considered as a component that will be operated in combination with final equipment. Since EMC performance will be affected by the complete installation, the final equipment manufacturers must re-qualify EMC Directive on the complete installation again. To fulfill requirements of the latest ErP regulation for lighting fixtures, this LED driver can only be used behind a switch without permanently connected to the mains. This series meets the typical life expectancy of >50,000 hours of operation when Ta is about 45°C or less. Please refer to the warranty statement on MEAN WELL's website at http://www.meanwell.com 			

■ BLOCK DIAGRAM

fosc : 100KHz

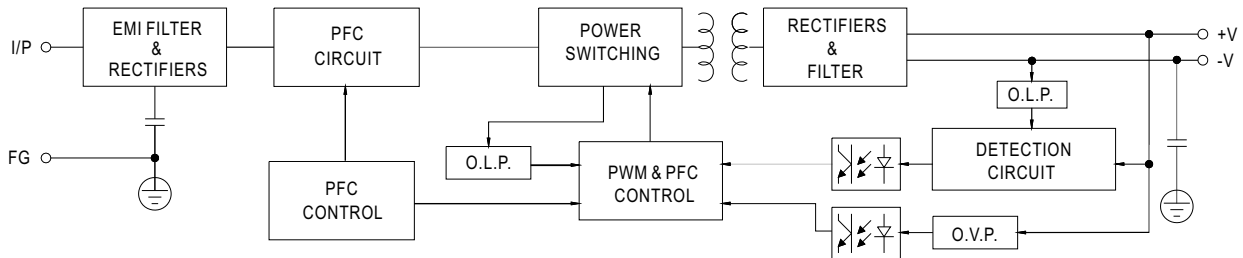

■ DRIVING METHODS OF LED MODULE

- ※ This series is able to work in either Constant Current mode (a direct drive way) or Constant Voltage mode (usually through additional DC/DC driver) to drive the LEDs.

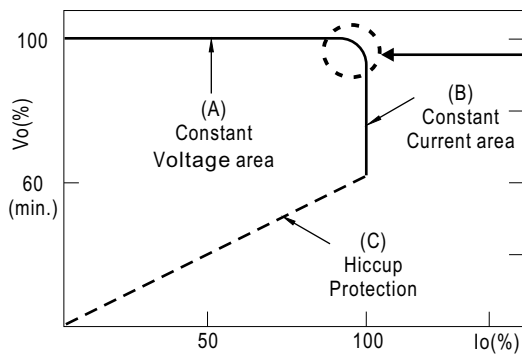

Typical output current normalized by rated current (%)

In the constant current region, the highest voltage at the output of the driver depends on the configuration of the end systems.

Should there be any compatibility issues, please contact MEAN WELL.

■ DIMMING OPERATION

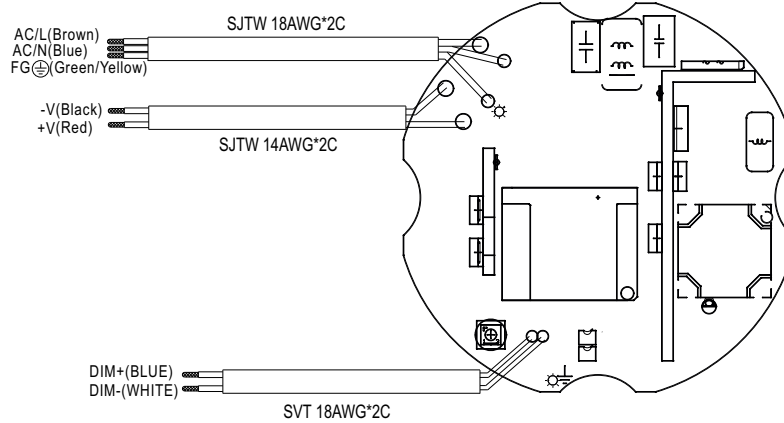

※ 3 in 1 dimming function (for B-Type)

- Output constant current level can be adjusted by applying one of the three methodologies between DIM+ and DIM-:
1 ~ 10VDC, or 10V PWM signal or resistance.
- Direct connecting to LEDs is suggested. It is not suitable to be used with additional drivers.
- Dimming source current from power supply: 100 μ A (typ.)

◎ Applying additive 1 ~ 10VDC

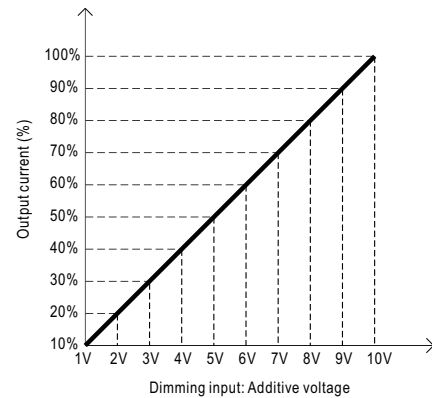
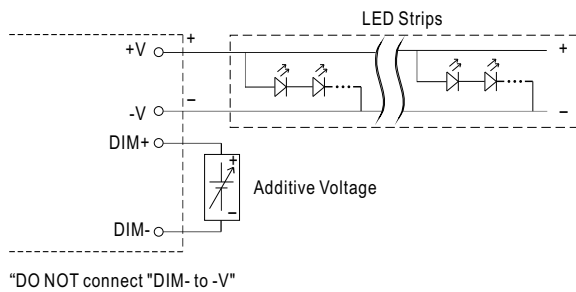

◎ Applying additive 10V PWM signal (frequency range 100Hz ~ 3KHz):

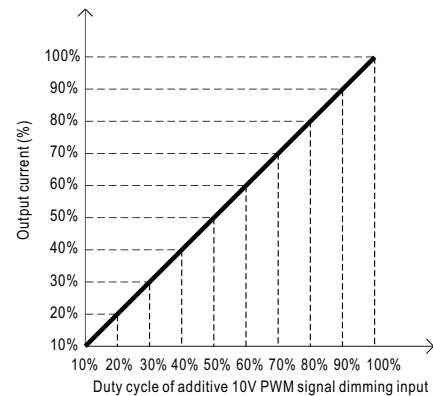
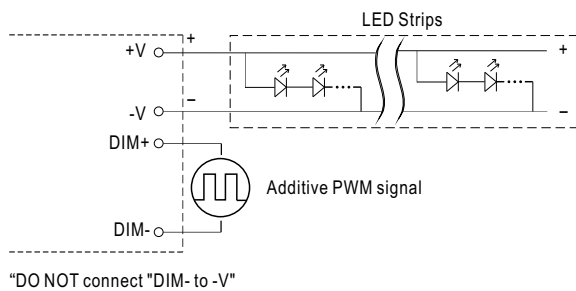

◎ Applying additive resistance:

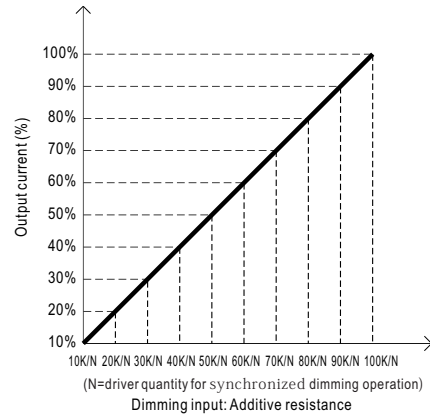
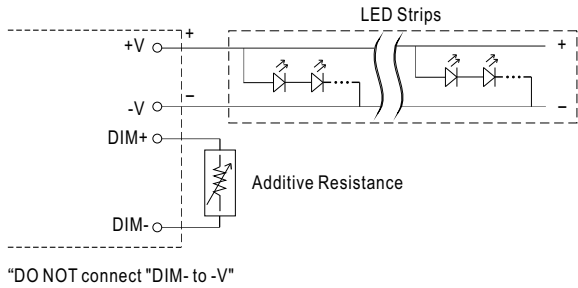

Note: In the case of turning the lighting fixture down to 0% brightness, please refer to the configuration as follow, or please contact MEAN WELL for other options.

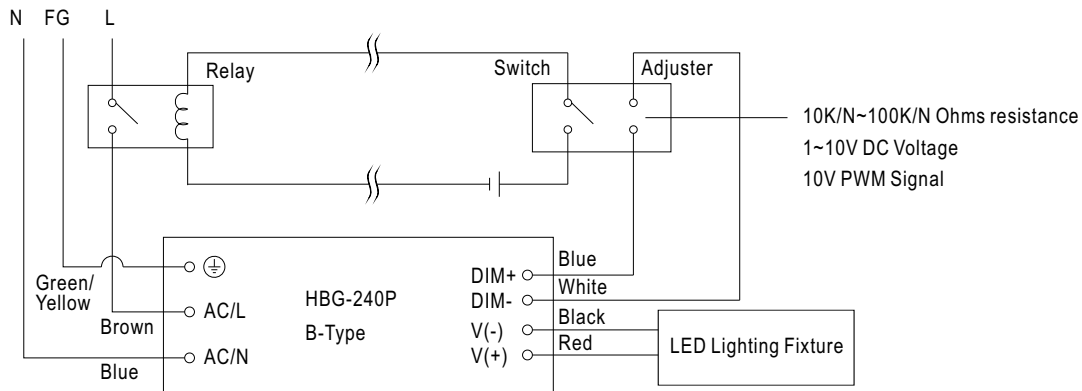

Using a switch and relay can turn ON/OFF the lighting fixture.

OUTPUT LOAD vs TEMPERATURE

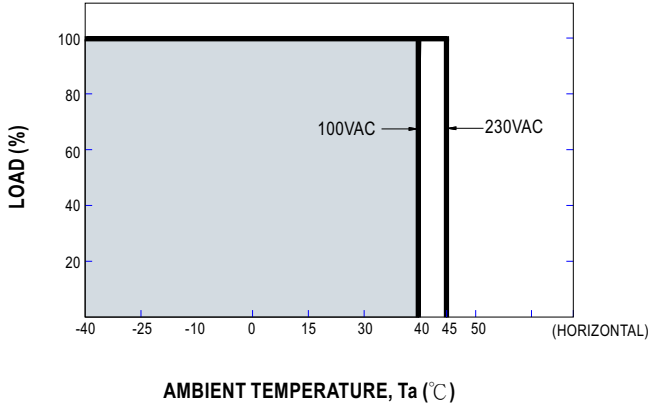

STATIC CHARACTERISTIC

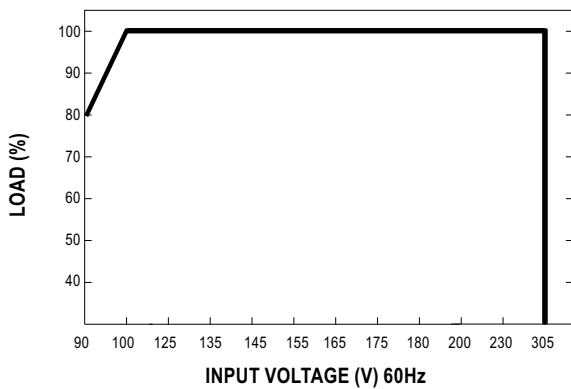

※ De-rating is needed under low input voltage.

POWER FACTOR (PF) CHARACTERISTIC

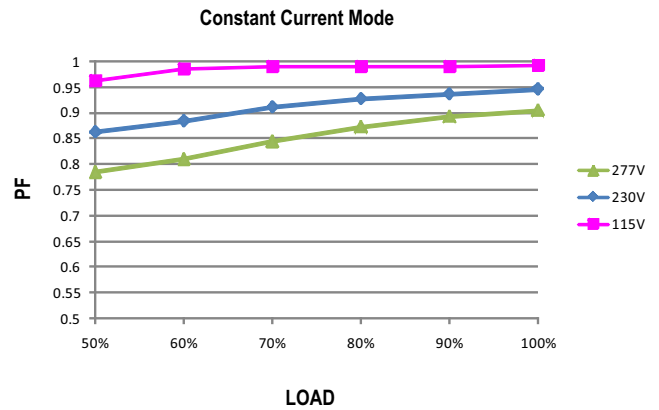

TOTAL HARMONIC DISTORTION (THD)

※ 60V Model

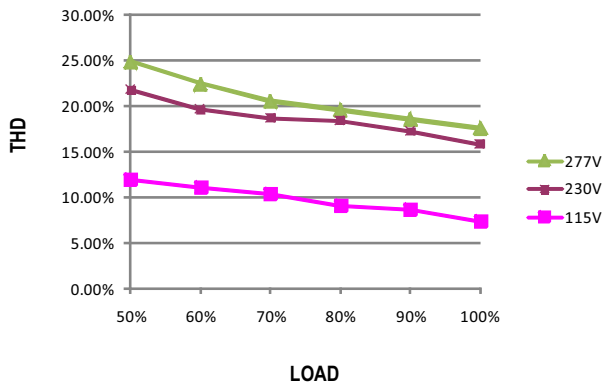

EFFICIENCY vs LOAD

HBG-240P series possess superior working efficiency that up to 93.5% can be reached in field applications.

※ 60V Model

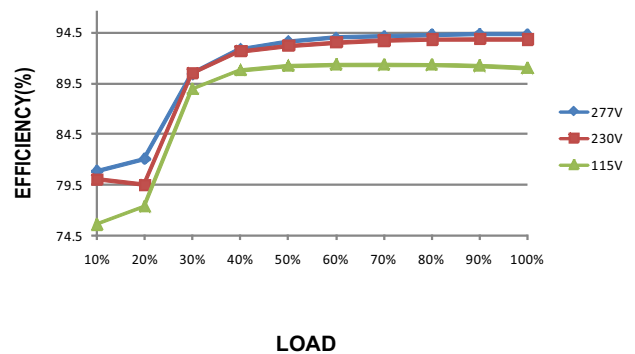

MECHANICAL SPECIFICATION

Unit:mm

※ A-type

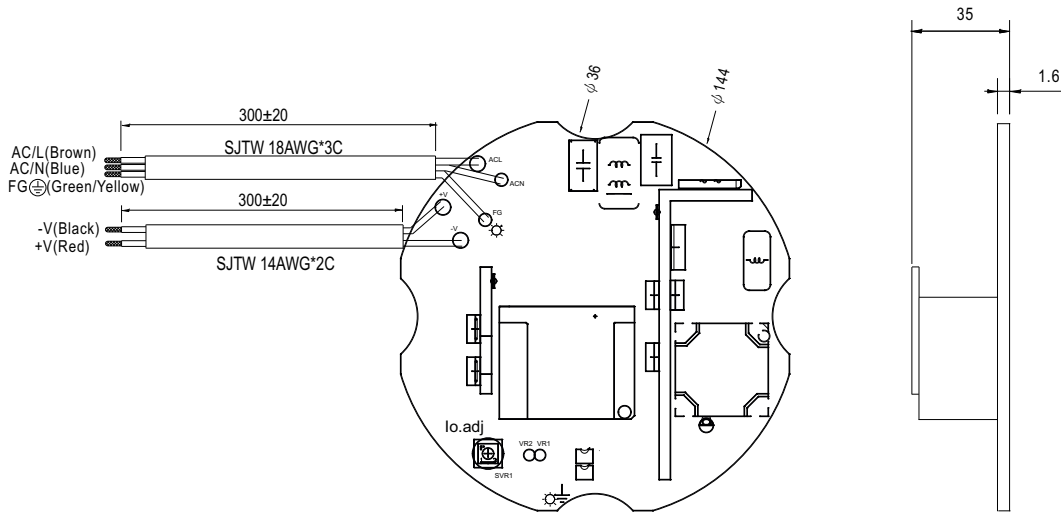

※ B-type

